

# BRISTAN

## Installation Instructions & User Guide

Please leave these instructions with the end user

Product Code: MZ SNK EF GM (D1)

### Specifications

#### Inlet Water Temperature

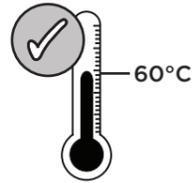

Maximum: 60°C

#### Dynamic Water Pressure

Min: 0.3 bar

Max: 5.0 bar



Maximum Static Pressure: 10.0 bar

#### Inlet Connections

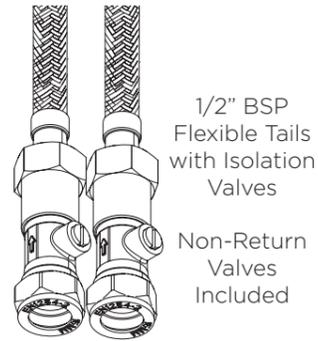

### Tools You'll Need

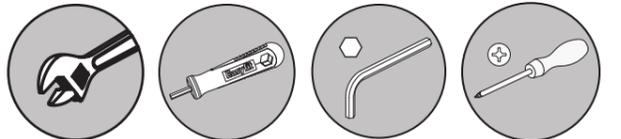

Adjustable Spanner EasyFit Tool Hexagonal Key Crosshead Screwdriver

### Flexible Connecting Pipes

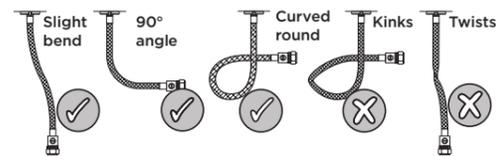

### Prior to Installation

All products manufactured and supplied by Bristan are safe to use provided that they are installed, operated and receive regular maintenance in accordance with these instructions.

This product needs to be installed in accordance with, and meet the requirements of the Water Supply (Water Fittings) Regulations 1999 and current by-laws. For full Installation Requirements & Notes (IRN) please visit [wras.co.uk/directory](http://wras.co.uk/directory).

Isolation valves must be fitted to the inlet water supplies to ensure ease of future maintenance.

Before installing this product the water supply must be thoroughly flushed in order to remove any swarf, solder etc. Full access must be made available for future maintenance/servicing purposes.

This product must not be modified in any way as this will invalidate the guarantee.

If in doubt, contact a registered plumber, your Local Water Authority or the Secretary of the Institute of Plumbing, address as follows:-

The Institute of Plumbing,  
64 Station Lane,  
Hornchurch,  
Essex,  
RM12 6NB, Tel: 01708 472791

### Pack Contents

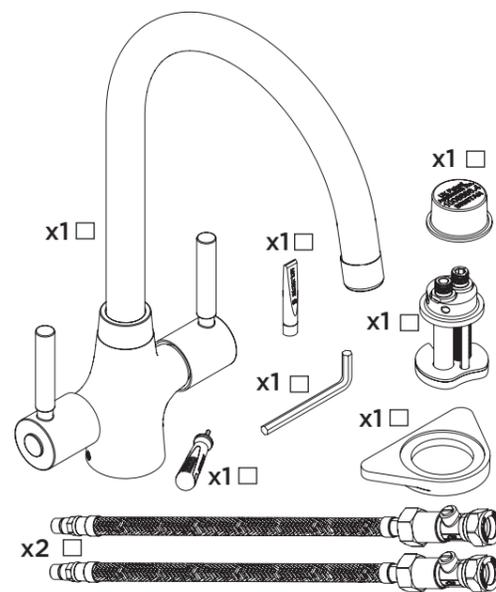

### Spare Parts

To replace any spare parts for your tap, why not scan the QR Code or visit [www.bristan.com](http://www.bristan.com) and search for your product.



### Installation

1

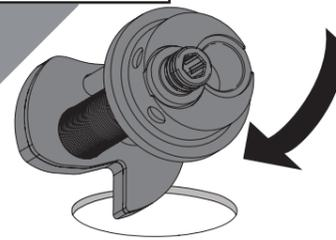

Feed the base through the sink hole from the top.



If the surface the tap is being fitted to is over 8mm; or you feel the tap needs extra stability, follow the **alternative installation steps** overleaf.

2

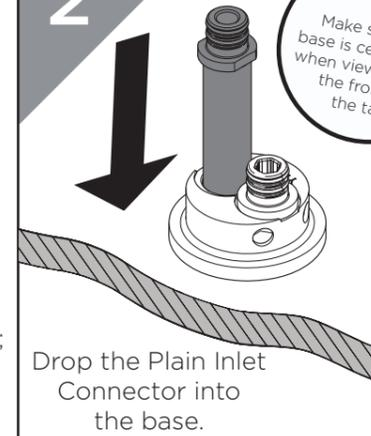

Drop the Plain Inlet Connector into the base.

**REMEMBER**  
Make sure the base is centralised when viewed from the front of the tap

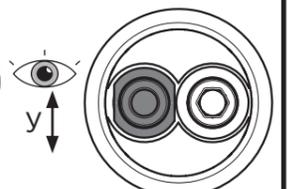

Ensure flat area of the plain inlet connector sitting flush adjacent to threaded inlet connector

3

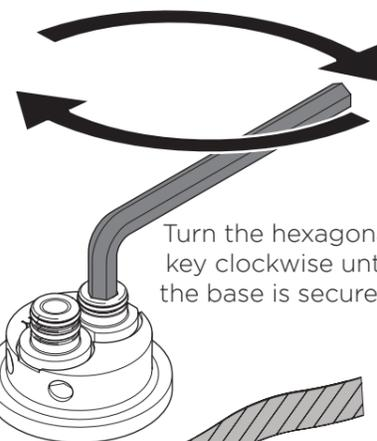

Turn the hexagonal key clockwise until the base is secured.

4

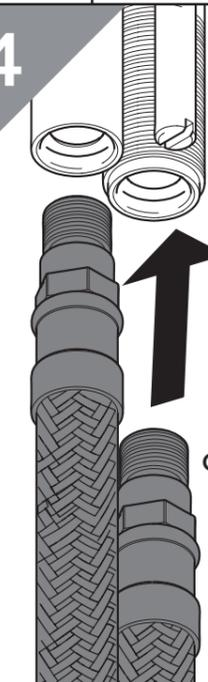

Screw the flexible tails into the base.

**DO NOT OVER-TIGHTEN**

5

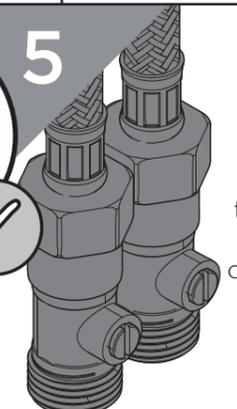

Connect the hot and cold water connections.

**REMEMBER**  
hot on the left, cold on the right

6



Grease the O-Rings using the Molykote Grease provided.

7

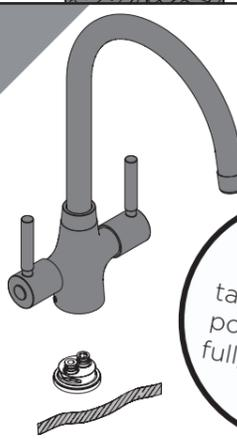

Place your desired tap onto the base.

**IMPORTANT**  
Ensure the tap is correctly positioned and fully located on the base

8



Secure in place with the grub screws using the tool provided.

9

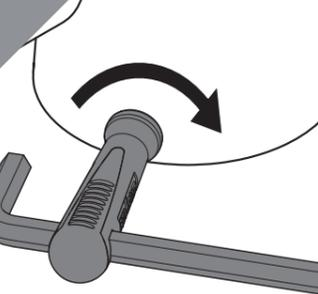

Thread the hexagonal key through the EasyFit tool and tighten the grub screws with an extra 1/2 turn.



### Operation

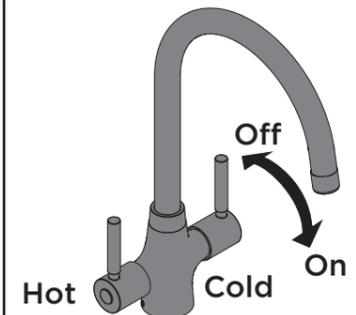

Your tap is now ready to use.

## Alternative Installation for Surfaces Out of Tolerance/Extra Stability

**1**

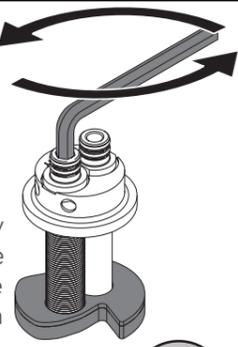

Turn the hexagonal key anti-clockwise to remove the back nut from the EasyFit Base.

**2**

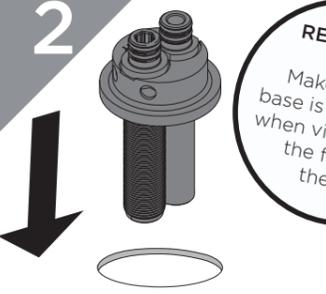

Feed the base through the sink hole from the top.

**REMEMBER**  
Make sure the base is centralised when viewed from the front of the tap.

**3**

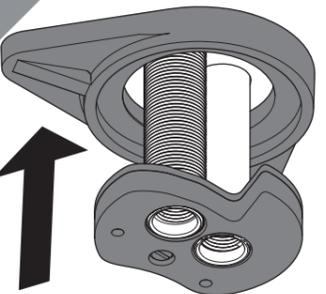

Feed the Reinforcing Plate (if required) and Back nut up to the underside of the sink.

**4**

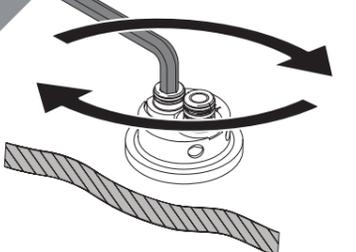

Turn the hexagonal key clockwise to secure the EasyFit Base.

**5**

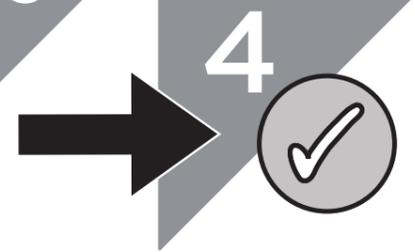

Proceed to Step 4 of the Installation Steps.

**Love Your Chrome**



Bristan offers an effective chrome-friendly cleaning kit for use with your taps and showers. Scan the QR Code or search for 'CLEAN KIT01' on [www.bristan.com](http://www.bristan.com).

## Maintenance - Cleaning/Replacing Outlet

**1**

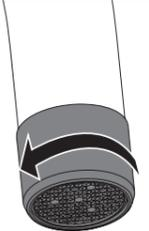

Unscrew the outlet housing.

**2**



Remove the outlet and washer from housing. Clean and replace as necessary.

**3**



Secure the outlet.

Turn on the mains water supply, letting the water flow for a few minutes to flush through the system.

## General Cleaning

Bristan products are made from premium materials, with hand polished, PVD, EPD or electroplated finishes.

Your tap should be regularly cleaned with warm water, a mild pH-neutral liquid soap, and polished with a soft cloth. Any residues from soap, toothpaste, shampoos and shower gels can cause blemishes if not rinsed off straight after use.

## Maintenance - Removing Cartridge

**1**



Remove handles.

**2**



Remove valves using a suitable spanner.

**3**



Reverse the steps to replace the cartridges/valves and handles.

**IMPORTANT**  
Isolate the water supply before starting!

Household bleaches and cleaners contain harsh chemicals and may damage the surface finish. Avoid using abrasive cloths, scouring pads, scrub sponges, steel wool or anything similar.

Some surfaces such as nickel and pewter may be affected by the dye found in some cloths, so it is also important to avoid hanging cloths on spouts.

## Troubleshooting

Symptom	Cause(s)	Remedy
<b>No flow or low flow rate</b>	Partially closed isolation valve.	Open isolation valve.
	Head of water is below the minimum distance required.	Refer to your the Specification for the minimum working pressure/distance required.
	Hot or cold water being drawn off elsewhere causing pressure changes or instantaneous boiler temperature changes.	Do not use other water outlets when using the taps.
	Airlock or partial blockage in the supply pipework or hoses.	Flush through pipework to ensure removal of debris and any airlocks.
	Water supply failure	Investigate water supply. Check your plumbing and heating systems for any faults.
<b>Water dripping from taps</b>	This is normal for a short time after using the taps.	This is caused by residual water tension, the build up of water in the tap body.
	If water continues to drip, possibly due to the ceramic disc valves/cartridge	Refer to the Maintenance section to replace the valves/cartridge.
<b>Taps do not turn on</b>	Closed isolation valve.	Open isolation valve.
	Mains water supply turned off.	Turn on mains water supply.
<b>Wobbly Tap</b>	Grub screws are not tight enough at the base	Ensure the grub screws are fully tightened against the base
	Extra security may be required depending on the surface the tap is fitted on to.	Refer to the Alternative Installation steps in order to fit the Reinforcing Plate.

## Notes

Please use this space for any notes you or your installer may have regarding the installation/plumbing of this product.

## Contact Us



**Bristan Group Ltd.**

**UK:** Bristan Group, B78 1SG.  
**EU:** Masco Europe S.à.r.l.  
 14 Rue Strachen  
 6933 Mensdorf  
 Luxembourg

**Customer Service:** +44330 026 6273  
**Web:** [www.bristan.com](http://www.bristan.com)  
**Email:** [enquire@bristan.com](mailto:enquire@bristan.com)

**A Masco Company**

## Our Guarantee

At Bristan, we want to make things as easy as possible for our customers. That's why we offer solid guarantees on all our products, effective from the date of purchase, to give you peace of mind.

To start your free guarantee simply scan the QR code and register your product. Alternatively visit [www.bristan.com/register](http://www.bristan.com/register).

For any other queries, please call our Customer Service on 0330 026 6273 where our expert team of advisors will be able to offer you any help and advice.

For full guarantee terms and conditions visit [www.bristan.com/service-centre/guarantees](http://www.bristan.com/service-centre/guarantees).

