

IRS BF C

IRIS Tap Range Iris Bath Filler Chrome



Features:

- Long life 1/4 turn ceramic disc valves for added durability and smooth control.
- Robust metal fixing nut to secure the tap in place reducing the risk of loosening over time.
- A hard-wearing, flawless, scratch resistant chrome finish that lasts for years. Salt spray tested to ensure added durability.
- 5 year parts and 1 year labour guarantee for peace of mind.
- Co-ordinating Bathroom taps and Accessories available

Product Certifications:



WRAS Certificate No: 1909916
WRAS Expiry Date: 30/09/2024

For more products, visit our website:
<http://www.bristan.com>



Specification

Product Type:	Bathroom Taps
Main Construction Material:	Brass
Mount Type:	Deck Mounted
Handle Type:	Lever Handle
Connection Inlet:	3/4" BSP
Connection Outlet:	M24 Aerator
Number of Tap Holes:	2
Valve/Cartridge Type:	3/4" Ceramic Disc Valve - 1/4 turn
Plumbing System Requirements:	Suitable for all plumbing systems
Minimum Dynamic Pressure (bar):	0.2 bar
Maximum Dynamic Pressure (bar):	5 bar
Maximum Hot Water Temperature °C:	60°C
Maximum Static Pressure (bar):	10 bar
Flow Type:	Single
Isolation Included:	No

Dimensions (measurements in mm)

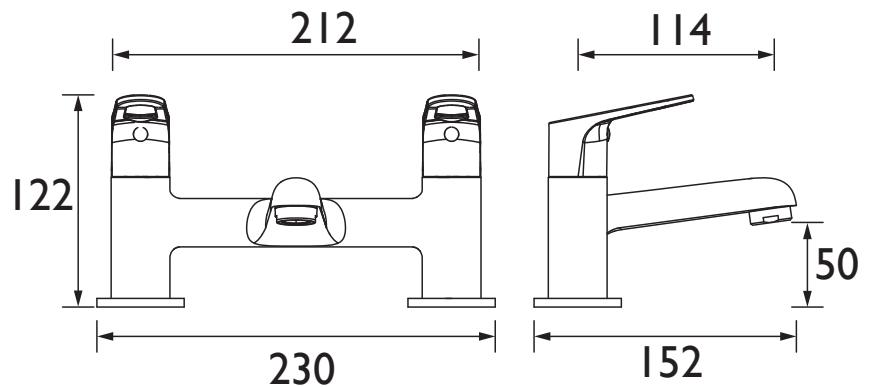

Flow Rates (l/min)

System Pressure (bar)	0.2	0.5	1	2	3	5
IRS BF C (mixed)	21.2	29.4	42	58	72	93
IRS BF C (hot)	13.5	22.1	31.4	44	54	70
IRS BF C (cold)	13.6	17.2	31.5	44.2	54.2	70.1

TECHNICAL DATA SHEET



BRISTAN

D5