

BRISTAN

TAPS & SHOWERS

Installation Instructions & User Guide

Please leave these instructions with the end user

Product Code: GLL SKQUA1.5 DR (D2)

Tools You'll Need

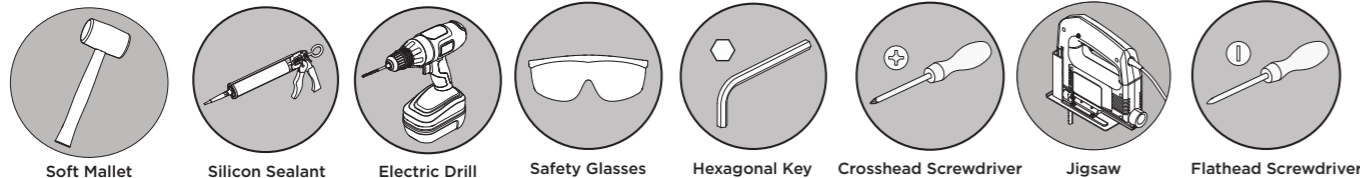

Pack Contents

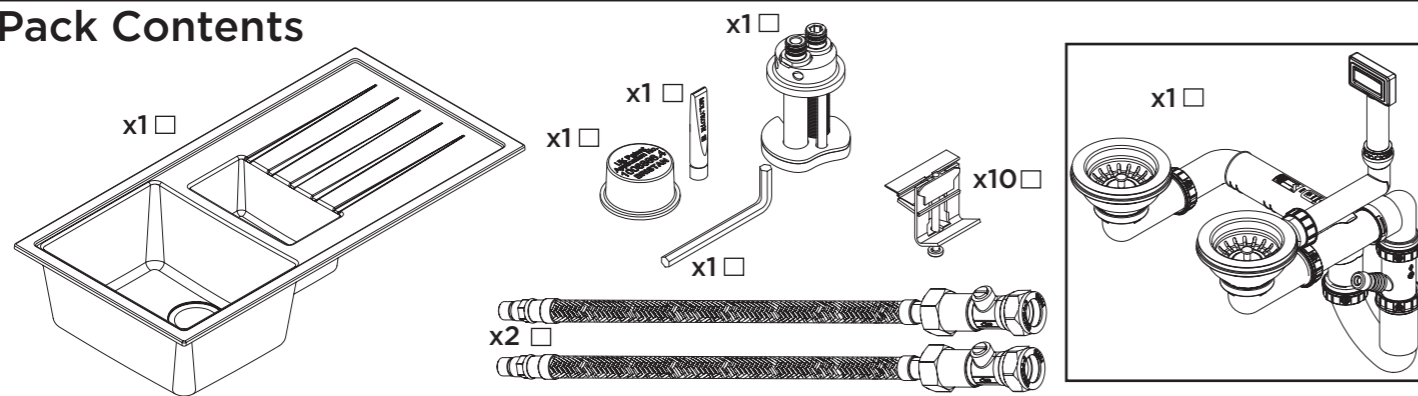

Prior to Installation

All products manufactured and supplied by Bristan are safe provided they are installed, used correctly and receive regular maintenance in accordance with these instructions.

This product has been tested to the Water Regulations Advisory Scheme (WRAS) and satisfies the requirements of the Water Supply (Water Fittings) Regulations 1999 and current bylaws. For full Installation Requirements & Notes (IRN) please visit wras.co.uk/directory.

Isolation valves must be fitted to the inlet water supplies to ensure ease of future maintenance.

Before installing these taps the water supply must be thoroughly flushed in order to remove any swarf, solder etc.

This product must not be modified in any way as this will invalidate the guarantee.

Before drilling into walls, check that there are no hidden electrical wires, cables or water supply pipes. This can be checked with the aid of an electronic detector.

If power tools are used do not forget to:
 - Wear eye protection
 - Unplug equipment after use

If in doubt, contact a registered plumber or your Local Water Authority or the Secretary of the Institute of Plumbing, address as follows:-

The Institute of Plumbing,
 64 Station Lane,
 Hornchurch,
 Essex,
 RM12 6NB, Tel: 01708 472791

Dimensions

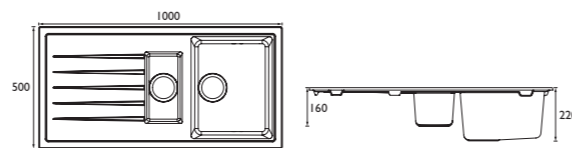

Inlet Connections

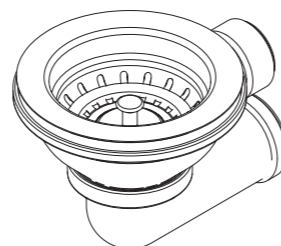

Waste Connection Size: G 1 1/2"

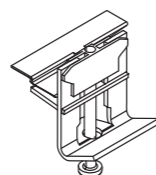

Min Worktop Thickness: 30mm
 Max Worktop Thickness: 40mm

Installation

1

Ensuring it's straight, place the Cutter Guide on the worktop and draw around the dotted line. Drill and cut the hole.

2

OR

REMEMBER
 Make sure the base is centralised when viewed from the front of the tap

Check the EasyFit base is correctly positioned. If you need to reinforce or adjust the base, **follow the steps overleaf.**

3

Gently knock all of the clips into place.

4

Screw the Overflow Connection into place

Cut the overflow pipe to the required size.

5

Fit the waste bodies to the sink. Secure in place with the screw.

REMEMBER
 The waste pipes can be cut to size to fit the sink

6

Connect to the waste body. Carefully turn the sink upside down.

7

Using the corners for guidance, apply a suitable sealant along the outer ridge. Place the sink in position.

8

Tighten the clamps to secure the sink.

9

Connect the waste to the domestic waste supply.

There is an optional connection for a water appliance.

Please refer to your appliance Fitting Instructions in order to connect the waste; or seal off with the rubber cap.

General Cleaning

Your Bristan product is made from a high quality composite resin; with 80% quartz and an anti-bacterial finish. Your sink should be regularly cleaned with warm water, a mild pH-neutral liquid soap, and dried with a soft cloth. Any residues from soap, food, toiletries etc. should be rinsed off straight after use.

Household bleaches and cleaners contain harsh chemicals and may damage the surface finish. Avoid using abrasive cloths, scouring pads, scrub sponges, steel wool or anything similar. Avoid scraping the sink basin or draining board with utensils or dropping heavy/sharp objects on to the sink surface. Do not place hot objects directly on to the sink.

Adjusting/Reinforcing the EasyFit Base

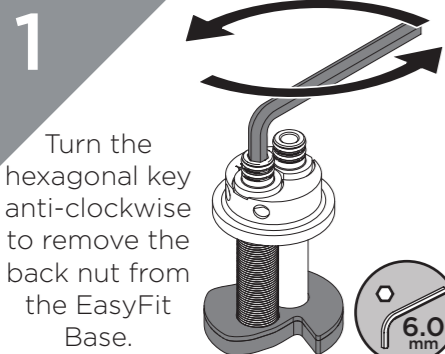

1 Turn the hexagonal key anti-clockwise to remove the back nut from the EasyFit Base.

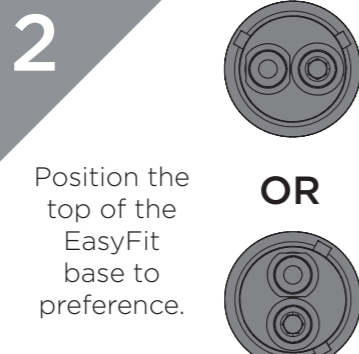

2 Position the top of the EasyFit base to preference.

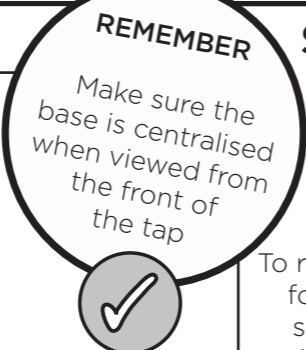

Spare Parts



To replace any spare parts for your sink, why not scan the QR Code or visit www.bristan.com and search for your product.

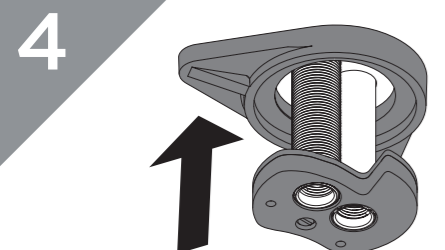

4 Feed the Reinforcing Plate (if required) and Back nut up to the underside of the sink.

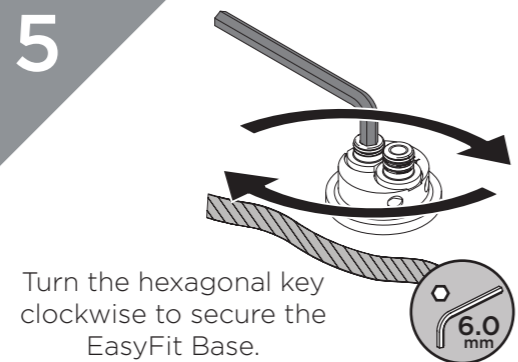

5 Turn the hexagonal key clockwise to secure the EasyFit Base.

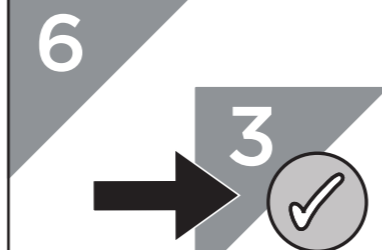

6 Proceed to Step 3 of the Installation Steps.

Maintenance - Unblocking the Sink

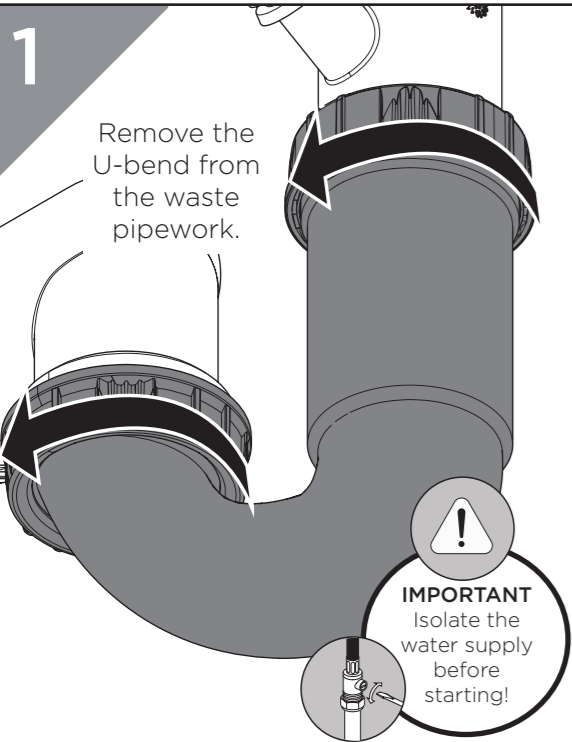

1 Remove the U-bend from the waste pipework.

IMPORTANT
Isolate the water supply before starting!

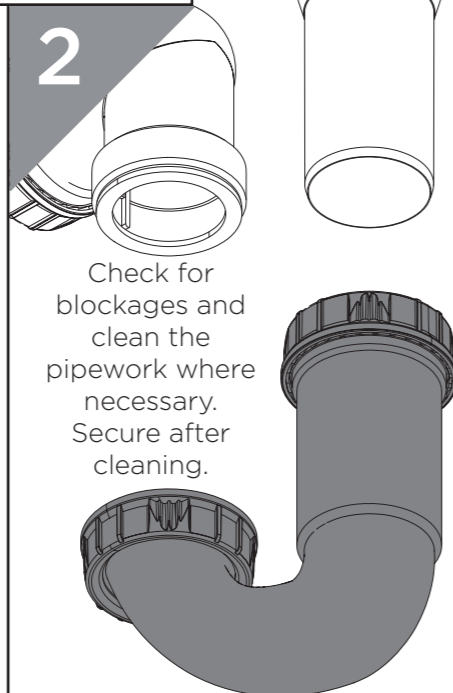

2 Check for blockages and clean the pipework where necessary. Secure after cleaning.

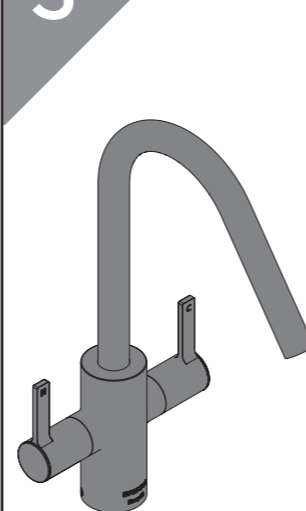

3 Let the water flow for a few minutes and check connections for any leaks.

Troubleshooting

Symptom	Cause(s)	Remedy
Sink is leaking	Loose waste connections	Check waste connections for any leaks, ensuring all O-rings are in place.
	Seal around the sink edge/plug lets water through	Add extra silicon sealant to those edges to ensure a water tight seal.
	Sink leaking from the overflow	Check the overflow seal and connections for damage. Ensure the screw is tightened.
Water isn't draining from the sink	Sink is blocked.	Refer to the Maintenance Section for Unblocking the Sink. If no blockage is found in the waste pipework, please contact your local Plumber for guidance.
Clamps do not grip the worktop	Worktop is under 30mm	Use a strong material e.g. wood to place under the worktop in order for the clamps to grip.
Wobbly Tap/ Sink is Flexing	Tap grub screws are not tight enough at the base	Ensure the grub screws are fully tightened against the base. See your EasyFit Tap Instructions.
	Extra security may be required to support the tap base.	Refer to the Alternative Installation steps in order to fit the Reinforcing Plate.

Notes

At Bristan, we want to make things as easy as possible for our customers. That's why we offer solid guarantees on all our products, effective from the date of purchase, to give you peace of mind.

To start your free guarantee simply scan the QR code and register your product. Alternatively visit www.bristan.com/register.

For any other queries, please call our Customer Service on 0330 026 6273 where our expert team of advisors will be able to offer you any help and advice.

For full guarantee terms and conditions visit www.bristan.com/guarantees.



We Know & We Care