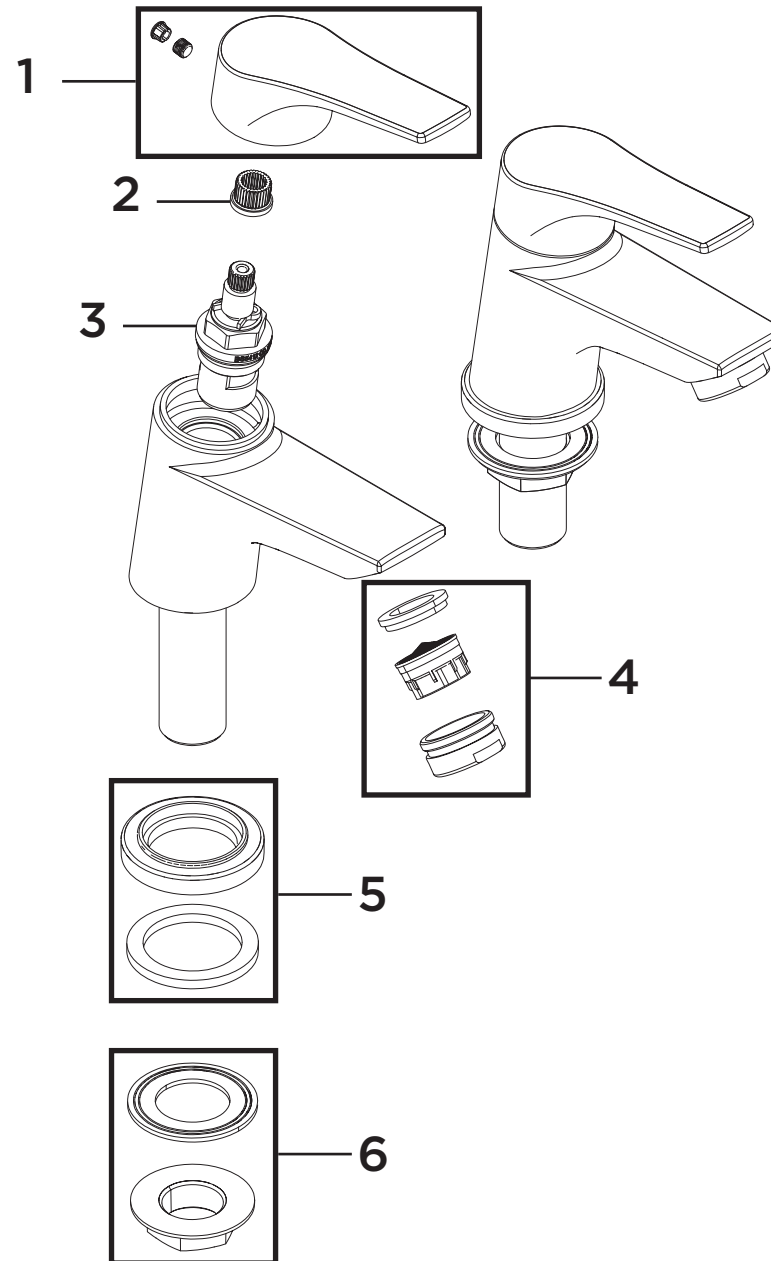

**Product Code:** VT2 3/4 C**Revision:** D1

1	Handle Assembly (Pair)
2	Spline Adaptor
3	3/4" Ceramic Disc Valves (Pair)
4	M24 Aerator
5	Plinth & Washer
6	Backnut & Washer (Pair)