

Product Code: CAS SHCVO C

Revision: D5

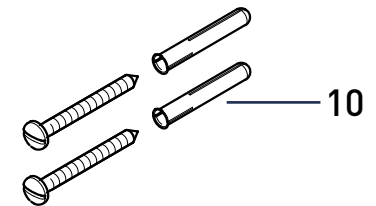
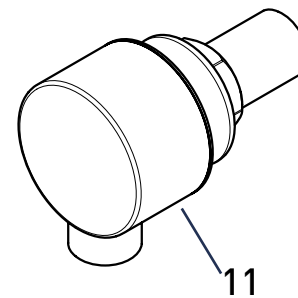
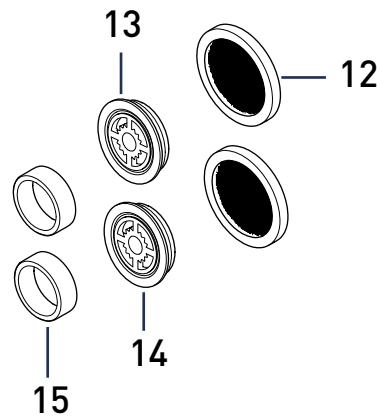
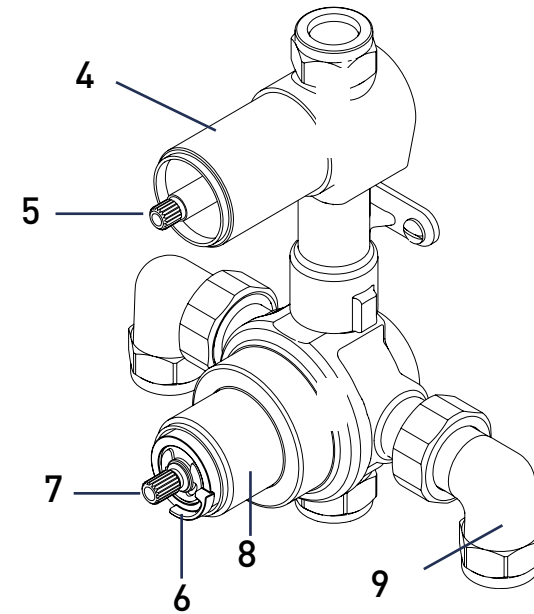
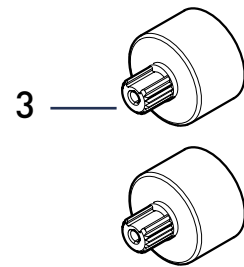
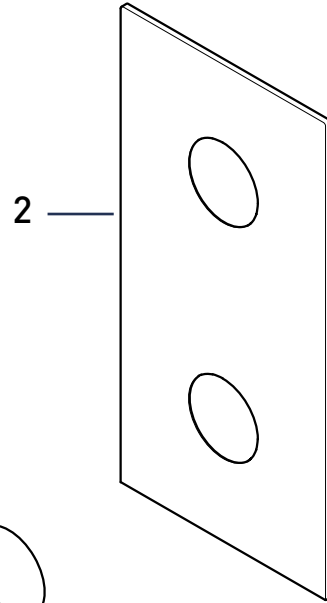
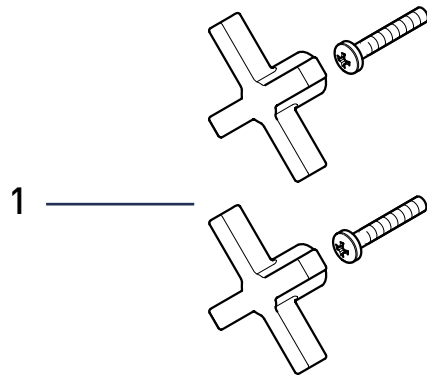

1	Handle Assembly
2	Concealing Plate
3	Handle Adaptors
4	Flow Shroud
5	Flow Valve
6	Temperature Stop
7	Thermostatic Cartridge
8	Temperature Shroud
9	Elbow Assey (Pair)
10	Fixings
11	Wall Outlet
12	Filter Washers
13	Flow Regulator
14	Flow Regulator
15	Inserts