

FH SLSQ02 C

SHOWER ACC Shower Range Stainless Steel Slimline 250mm Square Fixed Head



Features:

- Complete with swivel joint for angle adjustment

Product Certifications:



WRAS Certificate No: 2311903
WRAS Expiry Date: 30/11/2028



For more products, visit our website:
<http://www.bristan.com>



Specification

Finish/Colour:	Chrome Plated
Main Construction Material:	Stainless Steel
Shower Kit:	Fixed Head
Rub Clean Handset:	Yes
Mounting Type:	Wall
Plumbing System Suitability:	Suitable for all plumbing systems
Minimum Dynamic Pressure (bar):	0.2 bar
Maximum Dynamic Pressure (bar):	5 bar
Maximum Static Pressure (bar):	10 bar
Maximum Hot Water Supply Temperature °C:	85
Connection Inlet:	1/2" BSP Female
Isolation Included:	No
Check Valve Included:	No
What's Included:	1x Fixed Head, 1x Filter Washer, 1x Fitting Instructions

Dimensions (measurements in mm)

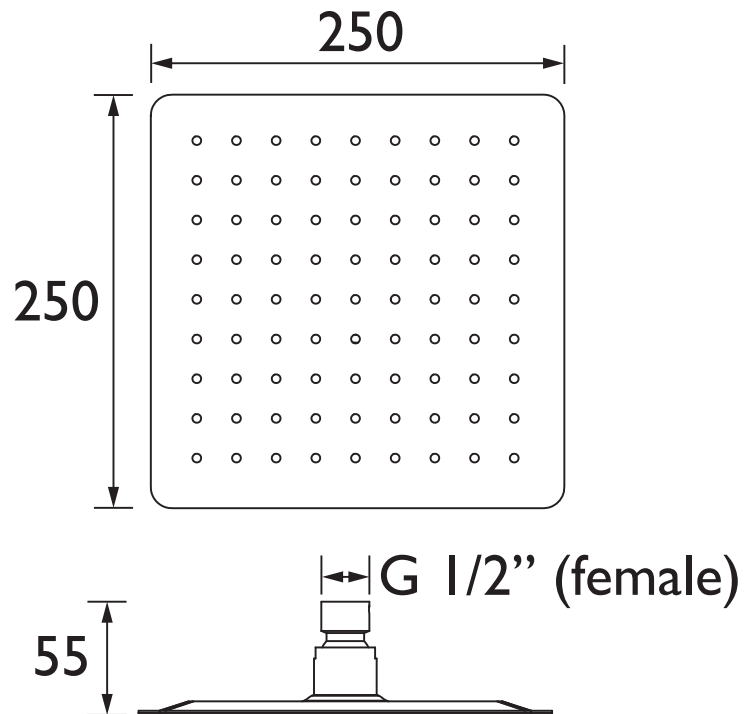

Flow Rates (l/min)

System Pressure (bar)	0.2	0.5	1	2	3	5
Through Fixed Head (mixed)	5.2	8.2	11.6	16.4	20.1	25.9

TECHNICAL DATA SHEET



BRISTAN

D4