

CNN EFSNK C

CINNAMON Tap Range Cinnamon Easyfit Monobloc Sink Mixer Chrome



Specification

Product Type:	Kitchen Taps
Main Construction Material:	Brass
Mount Type:	Deck
Handle Type:	Lever
Connection Inlet:	1/2" BSP Flexible Tails
Connection Outlet:	Anti-splash
Number of Tap Holes:	1
Valve/Cartridge Type:	35mm Cartridge
Plumbing System Requirements:	Suitable for all plumbing systems, ideally balanced
Minimum Dynamic Pressure (bar):	0.3 bar
Maximum Dynamic Pressure (bar):	5.0 bar
Maximum Hot Water Temperature °C:	60°C
Maximum Static Pressure (bar):	10 bar
Flow Type:	Single
Isolation Included:	Yes

Features:

- Long life ceramic cartridge for added durability and ease of use
- Metal fixing nut for added durability
- Easyfit base included
- Flexible tails included

Product Certifications:



WRAS Certificate No: 910904
WRAS Expiry Date: 31/10/2024



For more products, visit our website:
<http://www.bristan.com>



Dimensions (measurements in mm)

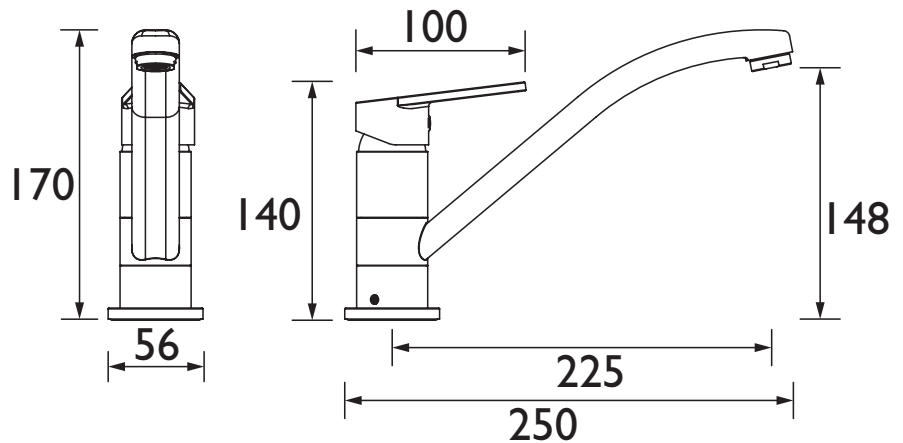

Flow Rates (l/min)

System Pressure (bar)	0.3	0.5	1	2	3	5
CNN EFSNK C (mixed)	6.1	7.2	10.8	15.5	19.2	25.1

TECHNICAL DATA SHEET



BRISTAN

D10