

IRWS1-CP

COMMERCIAL Tap Range Infra Red Automatic Basin Wall Spout



Features:

- Non-touch control, using Infrared sensing technology, supports infection control measures
- Mains or battery powered options
- Automatic switch off supports water saving
- BREEAM compliant
- Mains or battery powered options
- This tap outputs a fixed water temperature and should only be installed in conjunction with an approved thermostatic mixing valve to meet Part-G of the building regulations

Product Certifications:



WRAS Cert. Number: 2312371
WRAS Expiry Date: 31/12/2028



For more products, visit our website:
<http://www.bristan.com>



Specification

Product Type:	Commercial Type
Main Construction Material:	Brass
Mount Type:	Wall Mounted
Connection Inlet	G $\frac{1}{2}$ "
Connection Outlet:	5.7 lpm Aerator
Number of Tap Holes:	1
Valve/Cartridge Type:	Solenoid Valve
Plumbing System Requirements:	Suitable for high pressure systems
Minimum Dynamic Pressure (bar):	1.0 bar
Maximum Dynamic Pressure (bar):	5.0 bar
Maximum Hot Water Temperature °C:	65
Maximum Static Pressure (bar):	10
Flow Type:	Dual
Isolation Included:	No

Dimensions (measurements in mm)

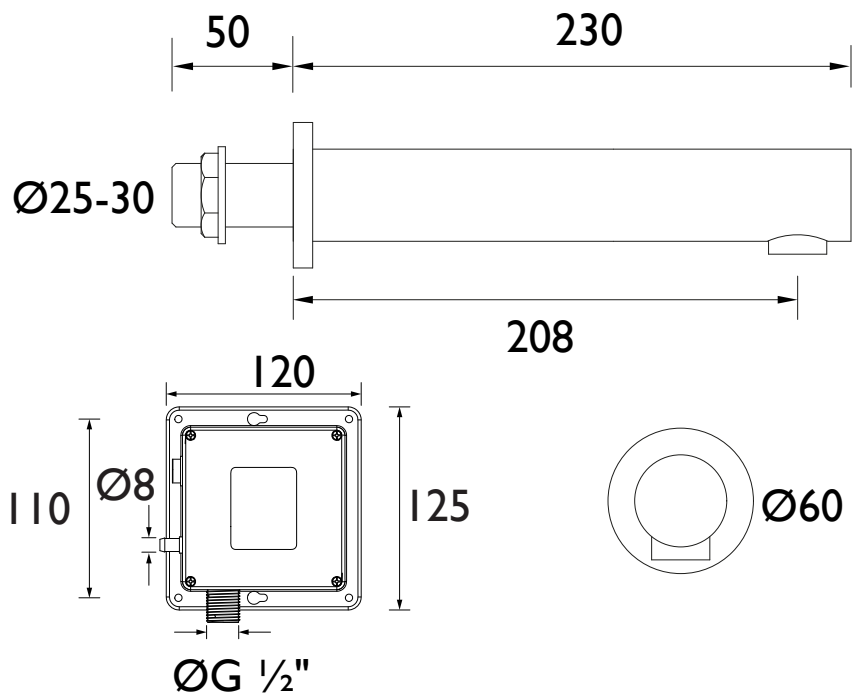

Flow Rates (l/min)

System Pressure (bar)	1.0	2.0	3.0	4.0	5.0
IRWS1-CP	3.5	4.7	4.9	5.0	5.2

TECHNICAL DATA SHEET



BRISTAN

D7