

# CAS KIT01 C

Step 1

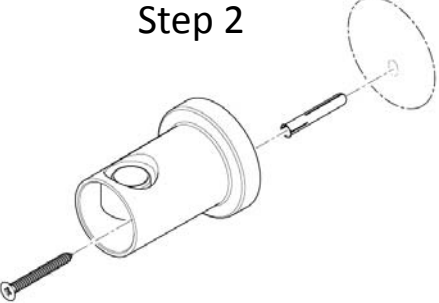

Step 2



Step 3

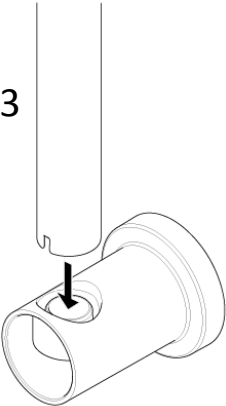

Step 4

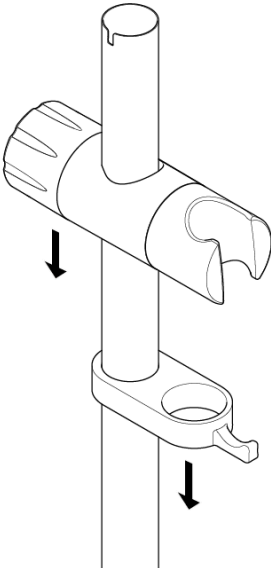

Step 5

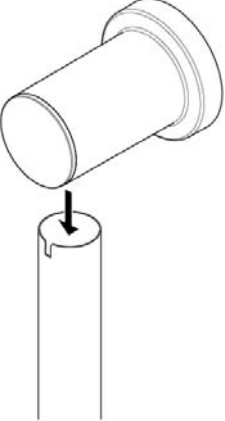

Step 6

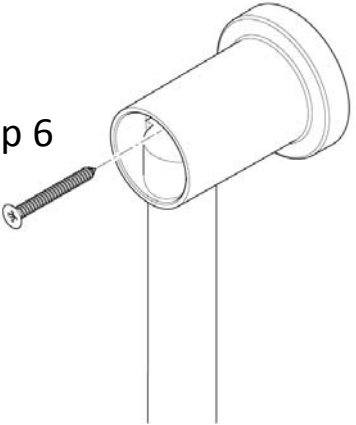

Step 7

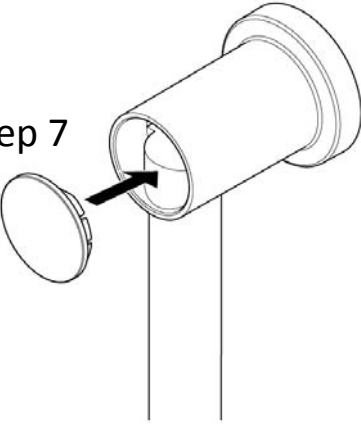

Step 7

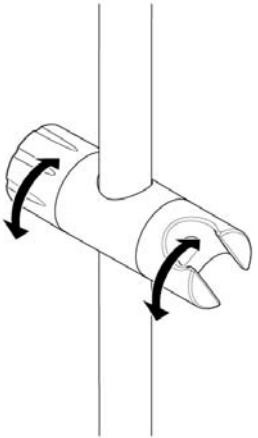
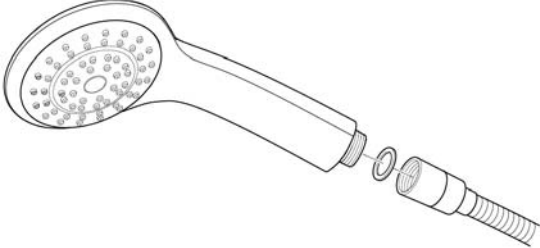

Slider operation