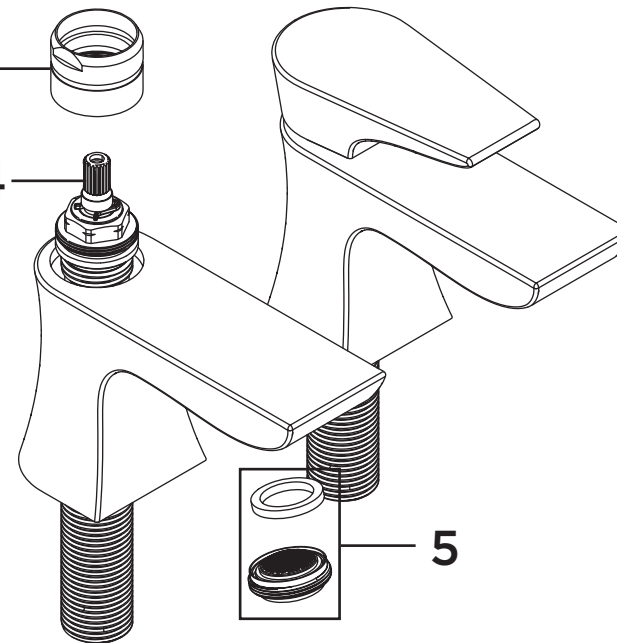
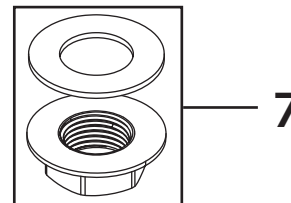
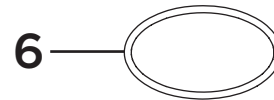
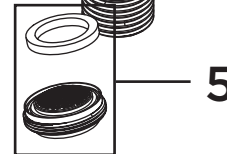
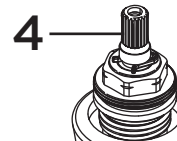
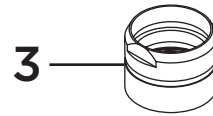
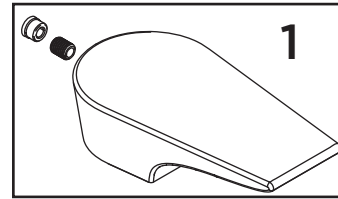

Product Code: HOU 3/4 RANGE**Revision:** D4

1	Handle Assembly (Pair)
2	Spline Adaptor
3	Shroud
4	3/4" Ceramic Disc Valves (Pair)
5	M24 Coin-Slot Aerator
6	Base Seal
7	3/4" Backnut & Washer (Pair)