

Product Code: HOU 1/2 RANGE

Revision: D4

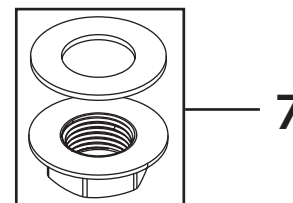
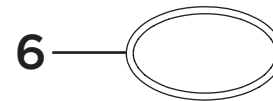
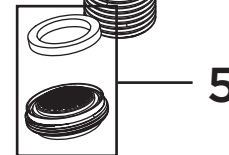
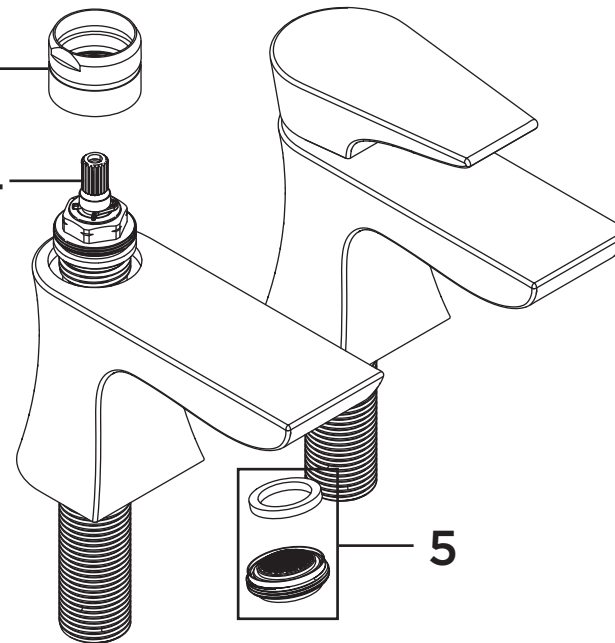
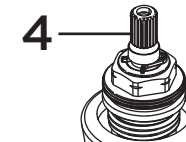
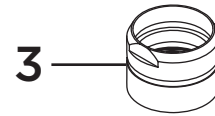
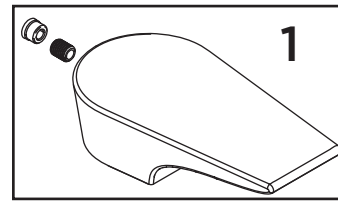

1	Handle Assembly (Pair)
2	Spline Adaptor
3	Shroud
4	1/2" Ceramic Disc Valves (Pair)
5	M24 Coin-Slot Aerator
6	Base Seal
7	1/2" Backnut & Washer (Pair)