

NR BSM E8 C

NERO Tap Range Nero Bath Shower Mixer Eco8 Chrome



Features:

- Metal handles
- 1.5m Hose
- Wall bracket
- 8 l per min flow regulator

Product Certifications:



For more products, visit our website:
<http://www.bristan.com>



Specification

Product Type:	Bathroom Taps
Main Construction Material:	Brass
Mount Type:	Deck mounted
Handle Type:	Lever Handles
Connection Inlet:	3/4" BSP
Connection Outlet:	M28 Flow Regulator
Number of Tap Holes:	2
Valve/Cartridge Type:	1/4 Turn 3/4" Ceramic Disc Valve
Plumbing System Requirements:	Suitable for all plumbing systems
Minimum Dynamic Pressure (bar):	0.2 bar
Maximum Dynamic Pressure (bar):	5.0 bar
Maximum Hot Water Temperature °C:	65°C
Maximum Static Pressure (bar):	10 bar
Flow Type:	Single Flow
Isolation Included:	No

Dimensions (measurements in mm)

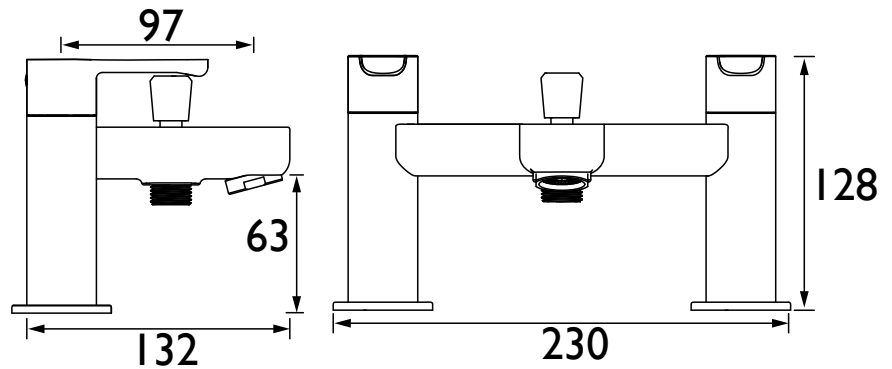

Flow Rates (l/min)

System Pressure (bar)	0.2	0.5	1	2	3	5
Through Bath Filler (mixed)	4.1	35.1	49.6	70.1	85.9	110.9
Through Handset (mixed)	8	8	8	8	8	8

TECHNICAL DATA SHEET



BRISTAN

D2